

Product: Resco Cubicle Series	Product Code: S-5000-FH-WW
Installation Guide Wall to Wall Version. October 2022	

# RESOCO

## Series 5000 *FH*

*Standard Full Height Cubicle Systems*

# Step-by-Step Installation Guide

## WALL TO WALL VERSION

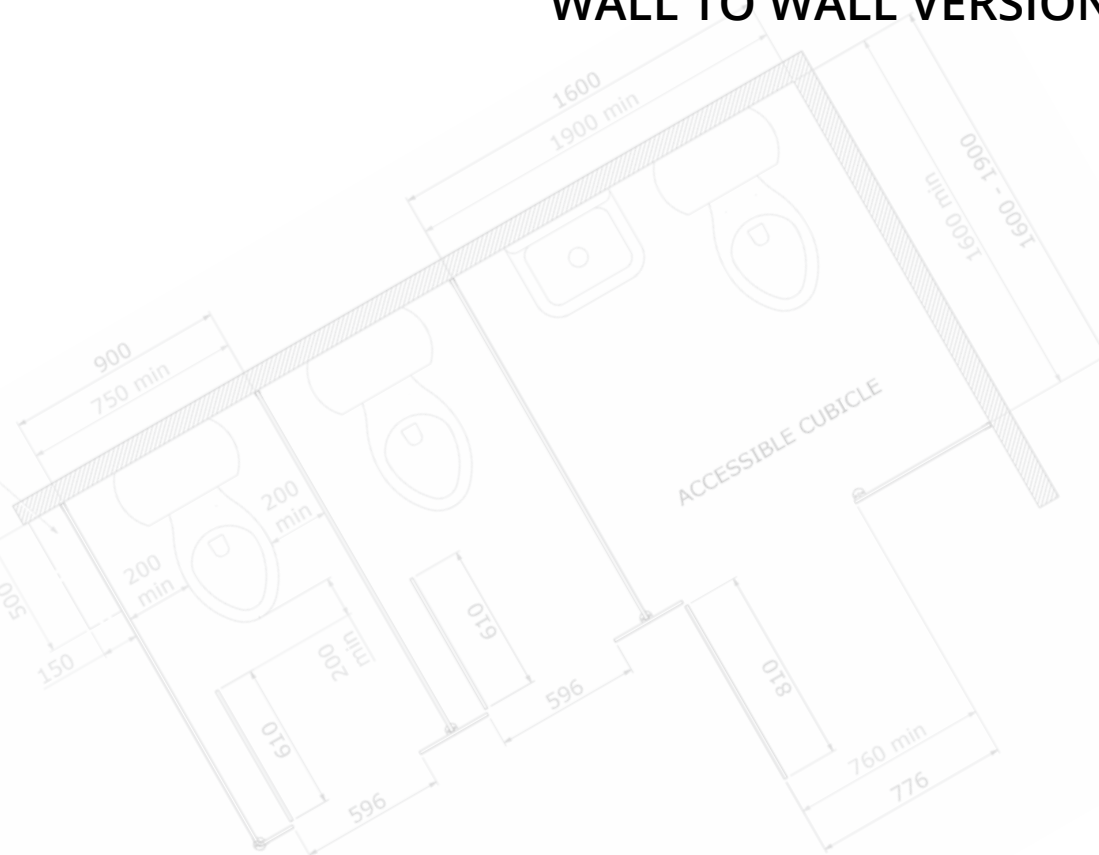

IMPORTANT

# SAFE PANEL HANDLING INSTRUCTIONS



Although Compact Laminate panels are tough and durable, they must be treated with care. Panels can be damaged if not stored or handled properly during assembly.

**STORE INSIDE** and keep in original packaging until needed.

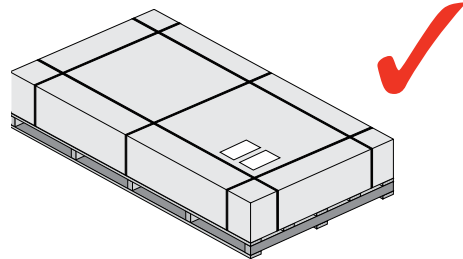

**USE CAUTION,** machined edges may be razor sharp!

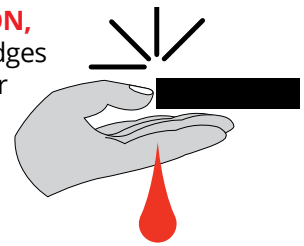

**DO NOT** store in sun or rain, or at high temperatures.

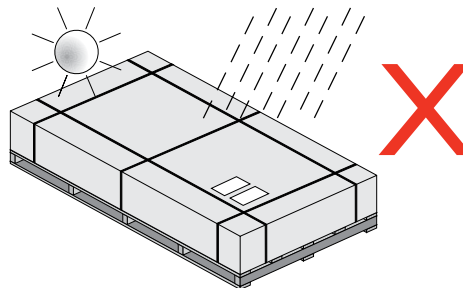

**DO NOT** slide panels - LIFT them!

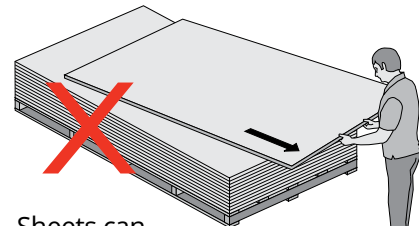

Sheets can scratch if not stored correctly - ensure free of dust and debris.

**2 MAN LIFT.**

Use suction lifting aids if available.

Take care when moving panels they can be damaged if not handled correctly.

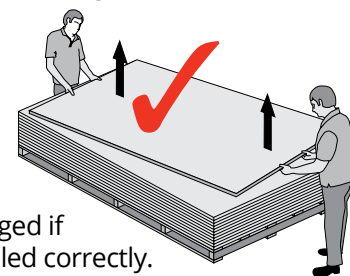

**DO NOT** walk-over.

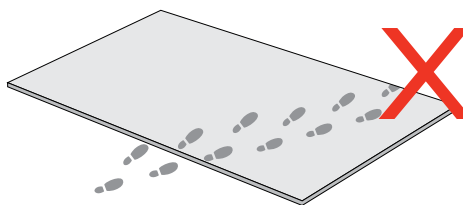

**PERSONAL PROTECTION.**

**Eye:** Dust resistant safety glasses should be worn when machining.

**Skin:** Protective gloves should be worn.

**Respiratory:** A class P1 or P2 replaceable filter or disposable half face piece particulates respirator should be worn when machining.

**Flammability:** Keep all storage and work areas well ventilated to avoid a buildup of dust that could ignite.

**FIRST AID MEASURES.**

**Eye:** Flush with flowing water for at least 15 minutes, and if symptoms persist seek medical attention.

**Skin:** Wash with mild soap and running water. Seek medical attention if symptoms persist. For cuts, clean wound and apply antiseptic dressing.

**Inhaled:** Leave the dusty area.

## CLEANING & MAINTENANCE OF COMPACT LAMINATE

Compact laminate is engineered to last for many years.

We provide a 10 year guarantee on panel integrity.

The non-porous surface is easy to clean. The decorative surface and resin core of Compact Laminate is impervious and resistant to most commonly used cleaning agents and disinfectants.



### Recommended cleaning agents

Surfaces can be easily cleaned with a dry or damp cloth and if necessary a mild household cleaner.

- **General cleaning:** All-purpose cleaner (e.g. Ajax Spray & Wipe), household cleaners, water or soap are recommended.  
It is resistant to everyday wear and tear but needs some attention for harsh conditions and staining.
- **Surfaces and edges:** Are easy to disinfect with hot water, steam and all common types of disinfectant used in hospitals and professional applications.
- **Spray paint:** Turpentine or SPC 801.
- **Permanent marker:** Methylated spirits or SPC 801.

### Never use any of the following on the panels, aluminium or hardware:

- Do not use abrasive or polishing materials. Abrasive cleaners such as Jif Cream Cleanser, Ajax (powder or liquid), Chemco, Brasso, Mr. Muscle oven cleaner or Scrub free.
- Scourer pads, Wire wool or Sandpaper.
- High pressure water cleaning or steam cleaning of panels is not recommended.
- Neat Janola or other equivalent brands of bleaches.
- Any product containing strong mineral acid such as sulphuric acid, Battery acid, hydrochloric acid, nitric acid or phosphoric acid. Commercial toilet cleaners, grout removers, descalants, rust removers, bleach, etc.
- Care must be taken where cleaning agents or solvents are highly acidic or alkaline as these may permanently damage the surface.

### Ongoing Maintenance:

- The use of CRC or equivalent on hinges and indicator bolts is recommended at least once every 3 months (sooner for challenging environments).
- An occasional re-finish of the exposed edges with an "off the shelf" wood-polish will rejuvenate the original polished seen edges.
- Any chemicals should be washed off so that they don't keep working.
- Finger prints and other such surface marks can be neutralised with a silicone spray and a micro-fibre cloth.

### See our Web site:

[www.resco.co.nz/product/multicom-cleaning-instructions](http://www.resco.co.nz/product/multicom-cleaning-instructions)

For removal of graffiti – Please call our customer service team **0800 800 950**

# Step-by-step Installation Guide

Follow the installation instructions and reference numbered steps on the illustrations.

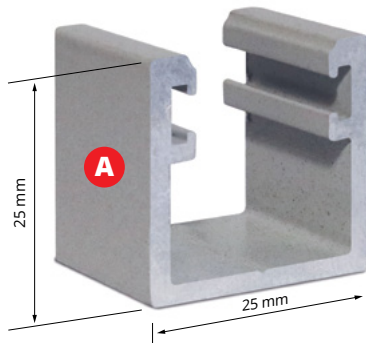

## Resco 8555 Channel

Used for horizontal fixings (ceiling & flooring).

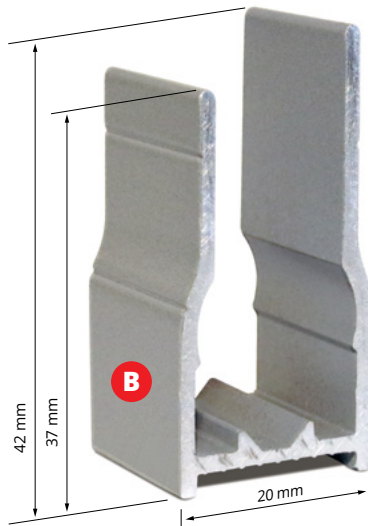

## Resco Wall Channel

Used for vertical fixings (walls).

# IMPORTANT NOTES

- When screwing into compact you must pre-drill.
- Use a low setting on your drills when screw fixing into Compact Laminate. Compact Laminate can break screws or damage the head if your drill is too powerful.
- Compact Laminate and Aluminium can damage if not stored or treated properly – take care when you are moving sheets. Larger sheets require 2-man lift.
- The system will be packed:
  - Top: Fascias  
*(Middle Fascias will have Resco Wall channels fixed to the back and Resco 8555 channels to the bottom)*
  - Middle: Doors
  - Bottom: Divisions>Returns
- Use Diamond tip drill bits for drilling into tiles.
- Continuous nogs or solid fixings are a **must** behind **all** channels on walls and ceiling.

Sit in place and ensure that all the doors are perfect before final rivet. Therefore you can adjust. Ensure to plumb both ways.

## Tools needed

- Solid line laser level (preferred)
- Level
- String line
- Chalk line
- Step ladder
- Rivet tool
- 3.5 mm drill bit
- 5 mm Masonry bit
- No. 2 Square drive bit
- Drop saw
- Circular saw

### Step 1

Using the shop drawings supplied, mark the front of the cubicles on the side walls and division centres on the back wall for the vertical **Resco Wall Channels** to be fixed. Plum pencil lines from floor to ceiling.

**Note: Use measurements according to shop drawings.**

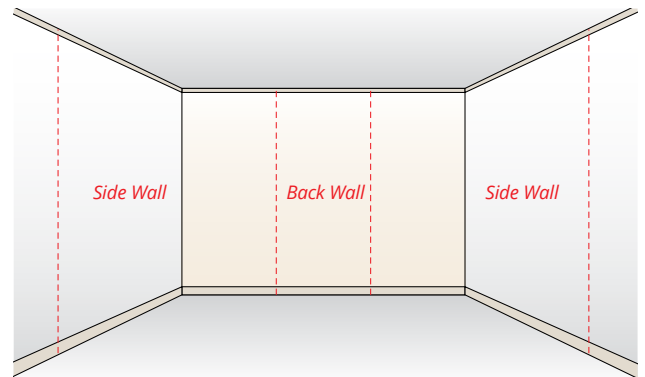

### Step 2

Using a chalk line, mark the front of the cubicles and division centres on the floor and ceiling for the **Resco 8555 Channels** to be fixed. These will be the centre lines of the channels.

**Note: Scotia and/or skirting will need checking out for channels (25mm).**

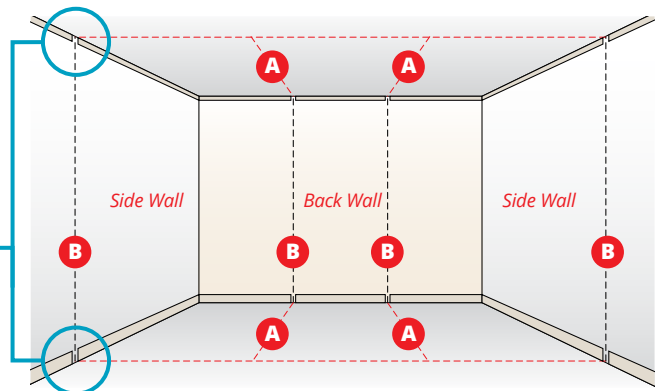

### Step 3 B

Cut the **Resco Wall Channels** to length for the back wall allowing for a 25mm gap at the bottom and top to allow for the top and bottom Resco 8555 channel.

Fix them to the back wall on the centre marks.

**Use (A) 8GA x 32 screws (with a (F) plastic anchor if required).**

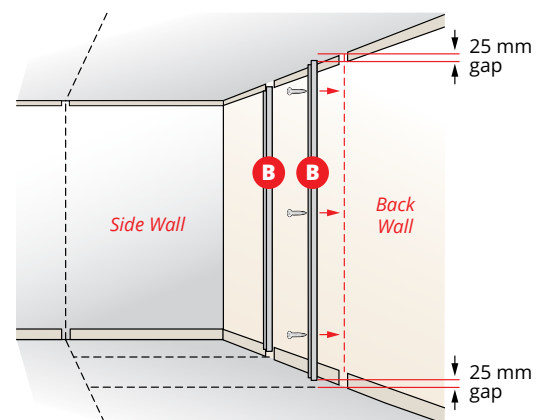

### Step 4

- 1 Cut to length **Resco 8555 Channels** and place onto both the top and bottom of the division panel and then lift the division panel up and slide back into the **Resco Wall Channel**.
- 2 Repeat with the next division panel.

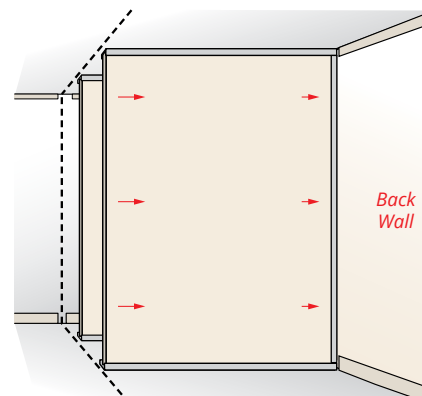

### Step 5

- 1 Measure wall to wall and cut a **Resco 8555 Channel** for the ceiling to fit between the side walls and pre-drill at 300mm centres.
- 2 Place the **Resco 8555 Channel** up against the ceiling and the **Resco 8555 Channels** for the divisions and then fix to the ceiling.

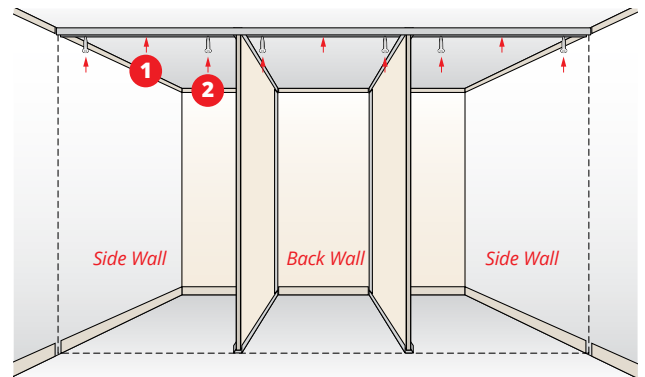

### Step 6 B

- 1 Cut the **Resco Wall Channels** to length for the side walls allowing a 25mm gap at the bottom. Fix the **Resco Wall Channels** to both side walls up underneath the ceiling **Resco 8555 Channel** leaving a 25mm gap at the bottom.
- 2 Place **Resco 8555 Channels** on the floor underneath the **Resco Wall Channels** on both side walls and screw to the floor.

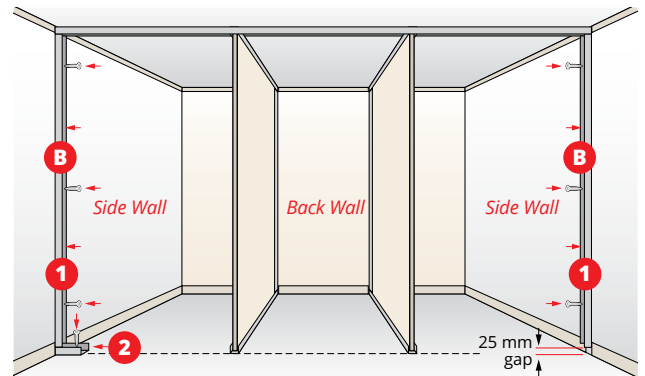

### Step 7

- 1 Start with the fascia which the first door will be hung from.
- 2 Slide the first fascia into the top & bottom **Resco 8555 Channels**, then push back into the vertical **Resco Wall Channel**.
- 3 Plumb up then drill and rivet in place through the back of the channels.

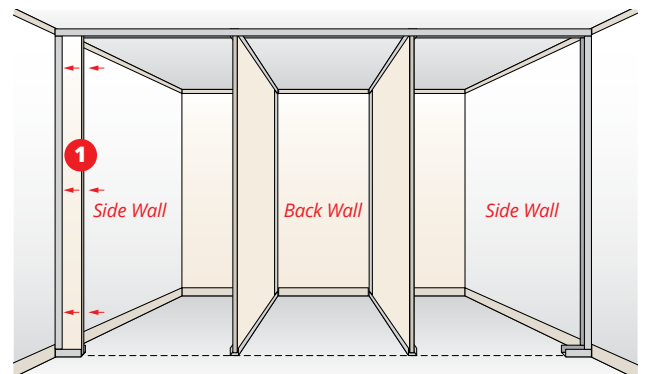

### Step 8 A B

- 1 Hang the first door to the fascia.
- 2 Fit the next centre fascia by pushing up inside the **Resco 8555 Channel** on the ceiling and then on to the front of the division panel.
- 3 Move the fascia and division over to gain approximately a 3mm door gap. Drill and screw the bottom **Resco 8555 Channel** into the floor inside the fascia rebate (on a slight angle).

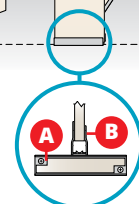
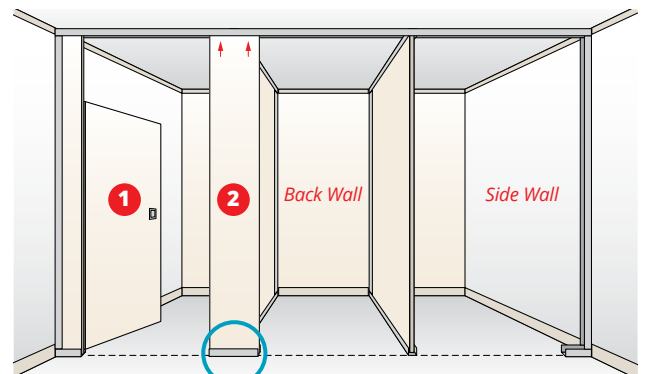

Fascia Plan View

### Step 9

Work your way along with the next fascia then door ensuring fascias are plumb.

### Step 10

Fit the pelmets into the top **Resco 8555 Channel**.

Make the gap between the top of the door and pelmet the same as the side door gaps by using temporary wedges. Then rivet through the back of the **Resco 8555 Channel** at the top from inside the cubicle into the pelmet and remove the wedges.

Use a 50mm bead of black sealant on either side of the pelmets inside the rebate to stop it moving at the bottom.

Tape in place if needed until sealant cures.

**Note: At this stage if required to make the top Resco 8555 Channel on top of the dividers tight to the ceiling, push up into the ceiling and put one rivet on one side into the divider.**

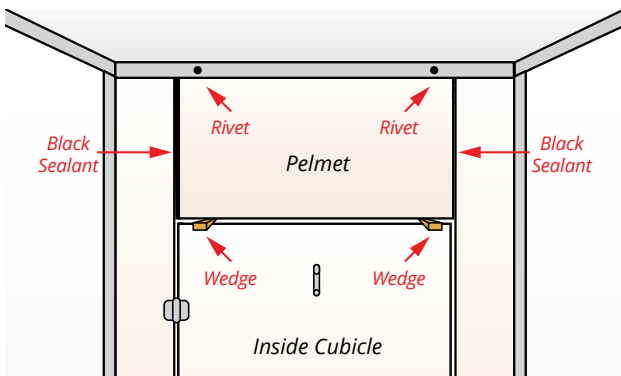

### Step 11 Fit hardware.

#### MODA COAT HOOK

Line up the coat hook with the pre-drilled holes in the doors and screw on.

**Use (B) 8GA x 12 screws.**



### SERA LOCK AND INDICATOR SET

These will be pre-installed with your colour preference.

#### Resco Silver Antimicrobial (ANMB)



#### Resco Black



### Step 12 Clean Panels

Clean all components, including pencil marks on the floor and walls.

Sweep the floor and remove rubbish.

Wipe down with soapy water.

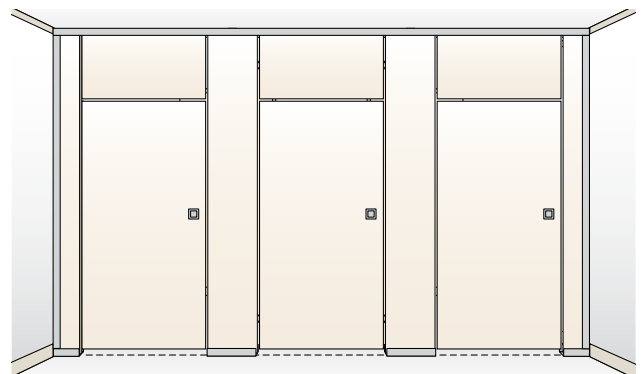

# RESCO

Resco Ltd.  
 12 Kahu Crescent, Te Rapa  
 Hamilton 3200, New Zealand  
**Freephone: 0800 800 950**  
 Phone: 07 850 1025  
 Fax: 07 850 1026  
 Email: [service@resco.co.nz](mailto:service@resco.co.nz)  
 Website: [www.resco.co.nz](http://www.resco.co.nz)